

LOCATELLI

CRANE



GRIL 8700T 
HEAVY DUTY

CARRO

TELAIO

Scatolato e saldato, costruito con materiali ad alta resistenza.

STABILIZZATORI IDRAULICI

Indipendenti idraulici con travi telescopiche ad uscita orizzontale e 4 cilindri verticali con valvole di blocco. Piedi di appoggio removibili. Comandi elettroidraulici con possibilità di escursione parziale azionati dalla cabina di guida.

MOTORE

CATERPILLAR ACERT C6.6, sei cilindri diesel turbo intercooler a controllo elettronico e raffreddamento ad acqua. Potenza max 168 kW a 2.200 giri/min. Coppia max 986 Nm a 1.400 giri/min. Filtro aspirazione aria a secco con cartuccia di sicurezza e indicatore di intasamento. Capacità serbatoio carburante 300 L.

TRASMISSIONE

Convertitore di coppia e cambio "power shift" con 6 marce avanti e 6 retromarce.

POMPE IDRAULICHE

Ad ingranaggi, una tripla ed una doppia, azionate dalle prese di forza sul convertitore e sul motore. Portata totale 460 L/min a pieno regime. Capacità serbatoio 560 L.

ASSI

Anteriore: traente/sterzante con differenziale e riduzioni planetarie montato rigidamente sul telaio.

Posteriore: traente/sterzante con bloccaggio differenziale e riduzioni planetarie, oscillante per l'impiego fuoristrada. Bloccaggio automatico dell'oscillazione dell'asse posteriore per il lavoro su gomme.

STERZO

Anteriore: azionato idraulicamente con comando a volante.

Posteriore: indipendente, idraulico con indicatore di allineamento ruote posteriori. Quattro possibilità di sterzata: solo ruote anteriori; ruote posteriori; coordinata; a granchio. Blocco meccanico dello sterzo posteriore per marcia su strada.

FRENI

Di servizio/emergenza: ad aria a doppio circuito indipendente. Comando a pedale con su tutte le ruote.

Di stazionamento: con cilindro a molla agenti su tutte le ruote.

PNEUMATICI

23.50 x 25 – tipo "fuoristrada", montati in singolo.

IMPIANTO ELETTRICO

Di avviamento e illuminazione a 24 Volt conforme alla normativa CE.

TORRETTA

STRUTTURA TORRETTA

Costruita con piastre e profilati in acciaio ad alta resistenza.

BRACCIO TELESCOPICO

A 4 sezioni. Braccio a sfilamento completamente idraulico sincronizzato da 10,1 m a 32,3 m. Altezza massima testa braccio 35,4 m.

ROTAZIONE TORRETTA

Rotazione continua su 360°. Motore idraulico con riduttore a tripla riduzione epicicloidale. Freno di rotazione automatico a dischi multipli. Sistema a rotazione libera. Ralla a dentatura esterna. Bloccaggio manuale rotazione con comando dalla cabina di guida.

ARGANO

Idraulico a 2 velocità. Motore idraulico a pistoni a due stadi accoppiato a riduttore a doppia riduzione epicicloidale. Tamburo scanalato. Freno automatico a dischi multipli e valvola di controbilanciamento.

CABINA

Costruita in acciaio e sospesa elasticamente sul lato sinistro della torretta. Visibilità panoramica e completa di ampi vetri di sicurezza. Sedile dell'operatore scorrevole e regolabile in altezza e profondità.

COMANDI GRU

Manipolatori montati sui braccioli del sedile operatore per il comando indipendente o simultaneo dei movimenti gru. Interruttori elettrici per il comando degli stabilizzatori, della marcia veloce dell'argano e per la rotazione libera.

DISTRIBUTORI

Distributori idraulici individuali garantiscono la combinazione simultanea dei movimenti della gru. Sistema centralizzato per il controllo delle pressioni idrauliche.

COMANDI DI TRASLAZIONE GRU

Volante inclinabile per il comando della sterzata ruote anteriori. Interruttore elettrico per la sterzata indipendente delle ruote posteriori. Selettore per il cambio di velocità, l'inversione di direzione e il freno di parcheggio. Interruttore elettrico per il comando delle marce lente e veloci con inserimento automatico delle 2/4 ruote motrici. Strumentazio

DISPOSITIVI DI SICUREZZA

Finecorsa salita e discesa gancio. Valvole di blocco su tutti i cilindri idraulici. Valvole di massima pressione su tutti i circuiti idraulici. Riconoscimento automatico configurazione stabilizzatori.

ACCESSORI A RICHIESTA

- Prolunga a traliccio inclinabile da 9,0 m
- Prolunga telescopica inclinabile da 10,0 m a 17,5 m
- Gancio a palla 5.000 kg
- Bozzello ad 1 carrucola da 15.000 kg
- Argano ausiliario tiro 4.000 kg
- Faro di lavoro (cabina e sezione base del braccio)

- Radiocomando
 - Indicatore elettronico di carico*
 - Dispositivo taglio movimenti*
 - Riscaldamento indipendente cabina *
 - Aria condizionata
 - Ruota di scorta
- *Accessori standard secondo le normative CE

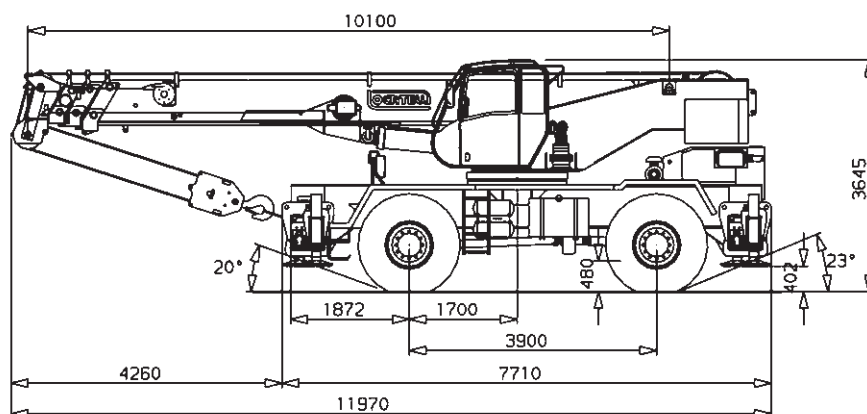

Dimensioni (mm)

CHASSIS

CHASSIS

Heavy duty, all welded box type section frame.

OUTRIGGERS

Four independent horizontal extension hydraulically operated outrigger beams with vertical hydraulic jacks and lock valves. Removable floats. Electro-hydraulic controls with partial extension facility controlled from the cab.

ENGINE

CATERPILLAR ACERT C6.6, six cylinders turbocharged intercooler diesel engine, electronically controlled and water cooled.

Max power 168 kW at 2.200 rpm. Max torque 986 Nm at 1.400 rpm. Dry type air cleaner with safety cartridge and service indicator. Fuel tank capacity 300 L.

TRANSMISSION AND TORQUE CONVERTER

Engine mounted torque converter driving an electro-hydraulically controlled power-shift transmission having 6 forward and 6 reverse speeds.

HYDRAULIC PUMPS

5 gear type hydraulic pump system, driven from two power-take-offs mounted on torque converter and engine. Total pumps capacity 460 L/min. Oil tank capacity 560L.

AXLES

Front: driving/steering axle with differential and planetary reduction solidly mounted to frame.

Rear: driving/steering axle with differential lockout and planetary reduction, pivot mounted. Automatic rear axle oscillation lockout.

STEERING

Front: hydraulically powered steering controlled by steering wheel.

Rear: independent hydraulically powered steering with rear wheel alignment indicator. Four steering modes: only front, only rear, coordinated and crab steering. Positive lock to hold in center line rear wheels for road travel.

BRAKES

Service and emergency: compressed air pressure dual independent braking system, foot operated on all wheels.

Parking: spring set, air released brake actuator acting on front axle.

TYRES

23.5 x 25 – earthmover type, single mounted front and rear.

ELECTRICAL EQUIPMENT

24 V starting and lighting equipment according to EC traffic regulations.

SUPERSTRUCTURE

SUPERSTRUCTURE FRAME

Fabricated from high tensile steel plate.

BOOM

4 sections 10,1 m to 32,3 m automatically synchronized fully powered telescopic boom. Max. boom head height 35,4 m.

BOOM ELEVATION

Single double-acting hydraulic cylinder. Elevation from -3° a $+80^{\circ}$.

SLEW

360° continuous rotation. Hydraulic motor driving slewing pinion through planetary triple reduction unit. Spring applied, hydraulically released multidisc type slew brake. Free swing device. External gear teeth slew ring. Hand operated slewing lock, controlled from the operator's cab.

MAIN HOIST

Hydraulic, two speeds. Twin piston type hydraulic motor, driving grooved hoist drum through double reduction gear unit.

Spring applied, automatically released fail-safe hoist brake and counterbalance valve.

OPERATOR'S CAB

Turntable mounted on rubber grommets, left hand drive, fully enclosed, all steel construction with safety glass and operator's seat on slides with height and rake adjustment.

CRANE CONTROLS

Armrest mounted joysticks for independent or simultaneous operation of crane motions; electric switches for control of outriggers, fast hoist speed and free swing.

CONTROL VALVES

Individual valve banks permitting simultaneous independent control of multiple crane functions. Centralized system for hydraulic pressure control.

TRAVEL CONTROLS

Adjustable steering wheel for control of front steering axle. Electric switch for independent steering of rear axle. Transmission gear selection, forward-reverse shift and parking brake control. Control switch for high-low range speeds with automatic 2 or 4 wheel drive selection. Master gauge for engine diagnostic.

SAFETY DEVICES

Overhoist and overlower limit switches; lock valves on all cylinders; hydraulic overload valves on all systems.

Automatic outriggers extension sensing system.

MAIN OPTIONAL EQUIPMENT

- 9,0 m offsetable lattice extension
- 10,0 m - 17,5 m telescopic offsetable extension
- Single hook 5.000 kg capacity
- Hookblock 15.000 kg
- Auxiliary hoist, max line pull 4.000 kg
- Working lights (on cab and base boom)

- Remote control
- Motion cut equipment*
- Electronic safe load indicator*
- Independent cab heater/defroster*
- Air conditioned
- Spare tyre

*Standard equipment for CE machine

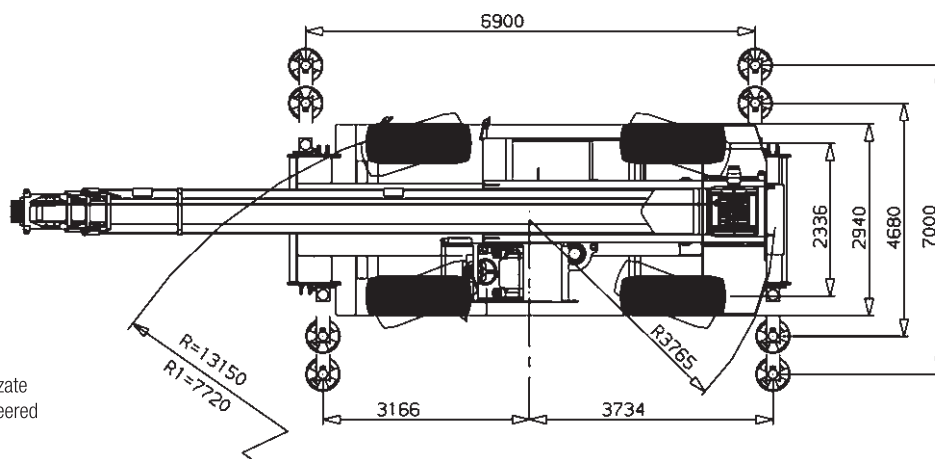

R1:
4 ruote sterzate
4 wheels steered

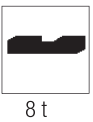
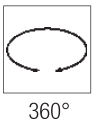
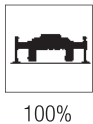
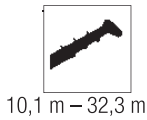

Dimensions (mm)

PORTATE BRACCIO TELESCOPICO - LIFTING CAPACITIES TELESCOPIC BOOM - CAPACITES DE LEVAGE FLECHE TELESCOPIQUE - TRAGLASTEN TELESKOPAUSLEGER - CAPACIDADES DE CARGA PLUMA TELESCOPICA



	10,1 m	13,8 m	17,5 m	21,2 m	24,9 m	26,7 m	28,6 m	32,3 m	
3,0	65,0								3,0
4,0	44,8	42,1	35,0						4,0
5,0	35,4	34,3	29,9	22,6	22,3	22,1	21,5		5,0
6,0	29,1	28,5	26,8	22,4	20,1	19,4	18,7	13,3	6,0
7,0	24,8	24,2	22,6	19,7	17,7	17,1	16,5	12,0	7,0
8,0		21,0	20,6	17,6	15,8	15,2	14,7	11,1	8,0
9,0		17,8	17,4	16,0	14,2	13,7	13,2	10,2	9,0
10,0		15,1	14,6	14,3	12,9	12,5	12,1	9,5	10,0
11,0		12,8	12,6	12,5	12,0	11,6	11,1	8,9	11,0
12,0			10,8	10,6	10,4	10,3	10,2	8,3	12,0
13,0			9,6	9,3	9,1	9,1	9,0	7,8	13,0
14,0			8,4	8,2	8,1	8,0	8,0	7,3	14,0
15,0			7,6	7,3	7,2	7,2	7,4	6,8	15,0
16,0				6,6	6,5	6,4	6,4	6,3	16,0
17,0				5,9	5,8	5,8	5,8	5,7	17,0
18,0				5,4	5,3	5,2	5,2	5,2	18,0
19,0					4,8	4,8	5,1	4,7	19,0
20,0					4,4	4,3	4,3	4,3	20,0
21,0					4,0	4,0	3,9	3,9	21,0
22,0					3,7	3,6	3,6	3,6	22,0
23,0						3,3	3,3	3,2	23,0
24,0						3,1	3,0	3,0	24,0
25,0							2,8	2,7	25,0
26,0							2,6	2,5	26,0
27,0								2,3	27,0
28,0								2,1	28,0
29,0								2,0	29,0

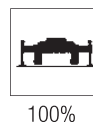
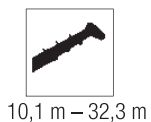



	10,1 m	13,8 m	17,5 m	21,2 m	24,9 m	26,7 m	28,6 m	32,3 m	
2,5	70,0								2,5
3,0	65,0								3,0
4,0	44,8	42,1	35,0						4,0
5,0	35,4	34,3	29,9	22,6	22,3	22,1	21,5		5,0
6,0	29,1	28,5	26,8	22,4	20,1	19,4	18,7	13,3	6,0
7,0	24,8	24,2	22,6	19,7	17,7	17,1	16,5	12,0	7,0
8,0		21,0	20,6	17,6	15,8	15,2	14,7	11,1	8,0
9,0		19,1	17,4	16,0	14,2	13,7	13,2	10,2	9,0
10,0		16,0	14,6	14,3	13,1	12,5	12,1	9,5	10,0
11,0		13,5	13,8	12,5	12,0	11,6	11,1	8,9	11,0
12,0			11,9	11,7	10,4	10,3	10,2	8,3	12,0
13,0			10,6	10,2	9,1	9,1	9,0	7,8	13,0
14,0			9,6	9,0	8,1	8,0	8,0	7,3	14,0
15,0			8,4	8,0	7,2	7,2	7,4	6,8	15,0
16,0				7,3	6,5	6,4	6,4	6,3	16,0
17,0				6,5	5,8	5,8	5,8	5,7	17,0
18,0				5,9	5,7	5,2	5,2	5,5	18,0
19,0					5,3	4,8	5,1	5,1	19,0
20,0					4,8	4,7	4,3	4,7	20,0
21,0					4,4	4,4	3,9	4,2	21,0
22,0					4,0	4,0	3,6	3,9	22,0
23,0						3,6	3,5	3,5	23,0
24,0						3,4	3,4	3,3	24,0
25,0							3,1	2,9	25,0
26,0							2,8	2,7	26,0
27,0								2,5	27,0
28,0								2,3	28,0
29,0								2,2	29,0

DIAGRAMMA DI LAVORO - WORKING DIAGRAM - DIAGRAMME DE TRAVAIL - ARBEITSBEREICH - DIAGRAMA DE TRABAJO



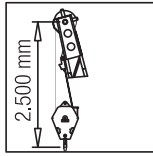
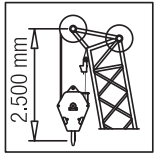
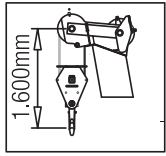

NOTE SULLA TABELLA DI PORTATE

- I carichi riportati nella tabella di portate sono a norme CE.
- Le portate sono indicate in tonnellate.
- Il peso dei bozzelli, delle prolungher braccio, delle imbracature e di qualsiasi altra attrezzatura di sollevamento deve essere detratto dalle portate indicate in tabella per ottenere il carico netto sollevabile.
- I raggi di lavoro sono misurati dal centro della ralla di rotazione.
- Per lunghezze di braccio e/o raggi di lavoro non elencati, usare il carico minore corrispondente alla lunghezza di braccio e/o al raggio di lavoro immediatamente successivi.
- Le portate su stabilizzatori sono valide solo se tutte le travi degli stabilizzatori sono completamente estese e la gru, accuratamente livellata, appoggia su una superficie di supporto solida.
- Le portate su pneumatici sono valide a condizione che i pneumatici siano gonfiati alla pressione prescritta e che la gru operi su un terreno piano, solido ed orizzontale:
 - per le portate statiche su 360° l'oscillazione dell'assale posteriore deve essere bloccata.
 - per le portate frontali in traslazione il fermo di blocco della rotazione deve essere inserito e la marcia con il carico sospeso deve essere eseguita con il carico leggermente sollevato da terra, prossimo alla gru, evitando oscillazioni del carico.

NOTES TO LOAD CHARTS

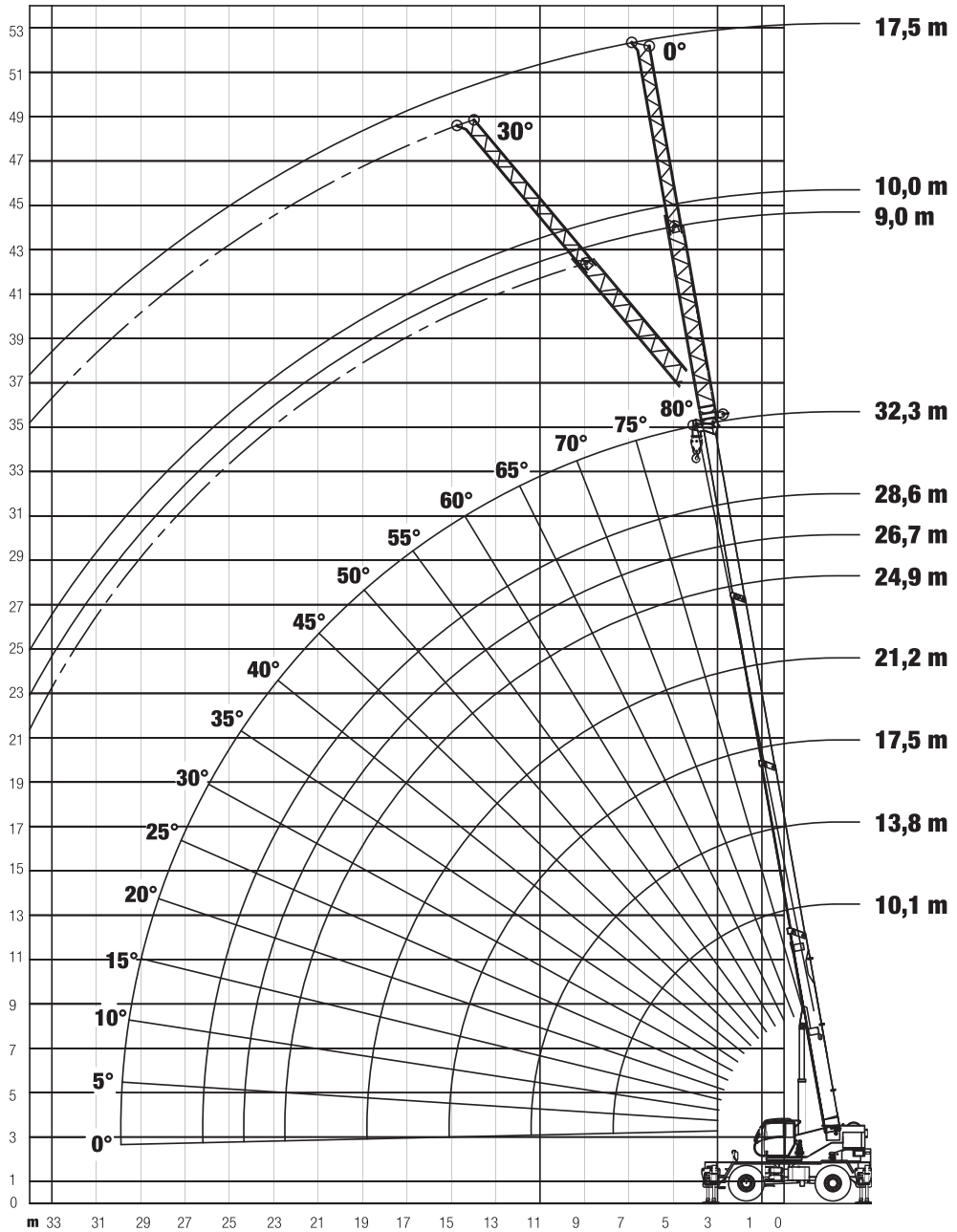
- The tabulated lifting capacities comply with the CE standards.
- Lifting capacities are given in metric tons.
- The weight of the hookblocks, boom extensions, sling and all auxiliary lifting devices must be deducted from the lifting capacities to obtain the net load to be lifted.
- Working radii are measured from the slewing centreline.
- For boom lengths and/or radii not listed use the smallest load given for the next longer boom length and/or radius.
- The capacities on outriggers are valid only if all outrigger beams are fully extended and the crane accurately levelled on a firm supporting surface.
- The capacities on tyres are valid only if the tyres are inflated to the recommended pressure and the crane works on a flat, solid and horizontal surface:
 - for 360° static capacities the rear axle oscillation must be locked.
 - for over front travelling capacities the swing lock pin must be fully engaged and the travel with suspended load should be carried out with the load little raised from the ground, close to the crane and avoiding load oscillations.





10,1 m - 17,5 m

23.50 x 25



360° / 0°

8 t

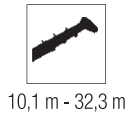

 m	0 km/h			3 km/h			 m
	360°			0°			
	10,1 m	13,8 m	17,5 m	10,1 m	13,8 m	17,5 m	
4,0	14,0	14,0	14,0	13,3	13,3	13,1	4,0
5,0	10,5	10,5	10,5	10,9	11,0	10,9	5,0
6,0	7,9	7,8	7,7	9,1	9,2	9,1	6,0
7,0	6,1	6,0	5,9	7,6	7,8	7,8	7,0
8,0		4,8	4,8		6,7	6,7	8,0
9,0		3,9	3,9		5,7	5,8	9,0
10,0		3,1	3,1		5,0	5,0	10,0
11,0		2,5	2,5		4,3	4,0	11,0
12,0			2,0			3,8	12,0
13,0			1,4			3,3	13,0

PORTATE PROLUNGA - LIFTING CAPACITIES BOOM EXTENSION - CAPACITES DE LEVAGE FLECHETTE TRAGLASTEN KLAPPSPITZE - CAPACIDADES DE CARGA PLUMIN



m	10,1 m		24,9 m		32,3 m		m
	9,0 m		9,0 m		9,0 m		
	0°	30°	0°	30°	0°	30°	
3,0	4,7						3,0
4,0	4,1		5,9				4,0
5,0	3,8	2,3	5,5		6,0		5,0
6,0	3,4	2,0	5,1		5,7		6,0
7,0	3,0	1,9	4,7		5,3		7,0
8,0	2,7	1,8	4,3	2,3	5,1		8,0
9,0	2,5	1,6	4,0	2,1	4,8	2,4	9,0
10,0	2,3	1,5	3,8	2,0	4,5	2,2	10,0
11,0	2,1	1,4	3,6	1,9	4,2	2,1	11,0
13,0		1,1	3,3	1,7	3,8	1,9	13,0
15,0			2,9	1,6	3,5	1,8	15,0
17,0			2,6	1,5	3,2	1,7	17,0
19,0			2,4	1,4	2,8	1,6	19,0
21,0			2,1	1,2	2,6	1,5	21,0
23,0			1,8	1,1	2,4	1,4	23,0
25,0				0,9	2,2	1,3	25,0
27,0					2,0	1,1	27,0
29,0					1,7	0,9	29,0
31,0						0,7	31,0
33,0						0,5	33,0

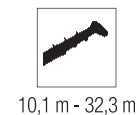

m	10,1 m				24,9 m				32,3 m				m
	10,0 m		17,5 m		10,0 m		17,5 m		10,0 m		17,5 m		
	0°	30°	0°	30°	0°	30°	0°	30°	0°	30°	0°	30°	
3,0			2,5										3,0
4,0	3,5		2,2		5,0								4,0
5,0	3,2	2,6	2,0		4,8		2,7		5,2				5,0
6,0	2,8	2,5	1,8		4,3		2,5		5,0		2,7		6,0
7,0	2,5	2,4	1,7		3,9		2,3		4,6		2,6		7,0
8,0	2,3	2,2	1,6		3,7		2,2		4,3		2,4		8,0
9,0	2,0	2,0	1,4		3,3	2,6	2,0		3,9		2,3		9,0
10,0	1,8	1,8	1,3	1,3	3,2	2,5	1,9		3,7		2,1		10,0
11,0	1,6	1,5	1,2	1,2	3,0	2,4	1,7	1,1	3,5	2,6	2,0		11,0
13,0		1,1	1,1	1,2	2,5	2,1	1,5	1,1	3,2	2,4	1,8		13,0
15,0			0,9	1,0	2,3	1,9	1,4	1,0	2,8	2,2	1,6	1,3	15,0
17,0				0,9	2,1	1,7	1,3	0,9	2,6	2,0	1,5	1,2	17,0
19,0				0,8		1,5	1,2	0,8	2,4	1,8	1,3	1,1	19,0
21,0						1,3	1,1	0,7	2,1	1,6	1,3	1,0	21,0
23,0						1,0	1,0	0,6	1,7	1,4	1,2	1,0	23,0
25,0							0,8			1,2	1,1	1,0	25,0
27,0										1,0	1,0	0,9	27,0
29,0											0,8	0,8	29,0
31,0											0,6	0,7	31,0
33,0												0,6	33,0

DATI TECNICI - SPECIFICATIONS - CARACTERISTIQUES - TECHNISCHE DATEN - DATOS TECNICOS

	Peso sugli assali Axle loads Poids d'essieux Achslasten Carga por eje	1	2	Peso totale Total weight Poids total Gesamtgewicht Peso total
	t	20,6	23,3	43,9

		4x4	1	2	3	R1	R2	R3		
	km/h		2,2	4,1	11,1	2,2	4,1	11,1		83%
	km/h		4x2	5,1	9,7	26,6	5,1	9,7		26,6
			23.50 x 25							

	Funzioni Mechanisms Mécanismes Antriebe Mecanismos	Progressivamente variabile Infinitely variable Progressivement variable Stufenlos Infinitamente variable	Diametro / Lunghezza fune Rope diameter / Rope length Diamètre / longueur du câble Seil ø / Seillänge Diámetro cable / longitud cable	Tiro max. ammissibile Max. permissible line pull Effort max. admis sur brin Max. zulässiger Seilzug Carga max. por reenvío
		0 - 120 m/min	18 mm x 185 m	57,4 kN
		0 - 62 m/min	15 mm x 120 m	39,2 kN
		0 - 2 min ⁻¹		
		-3° / +80°	↑ 70 s ca. / 70 s approx. ↓ 60 s ca. / 60 s approx.	
		10,1 m - 32,3 m	120 s ca. / 120 s approx.	

	Portata Lifting capacity Force de levage Traglast Capacidad de carga	N° di carrucole No of sheaves Nbr de poulies N° der Rollen No de poleas	N° di taglie No of lines Nbr de brins Strangzahl No de reenvíos	Peso Weight Poids Gewicht Peso
	65 t	6	12	670 kg
	15 t	1	3	290 kg
	5 t	-	1	100 kg

Simboli - Symbols - Symboles - Symbolen - Símbolos

	Braccio telescopico Telescopic boom Flèche télescopique Teleskopausleger Pluma telescópica		Prolunga braccio Boom extension Rallonge de flèche Klappspitze Extensión de pluma		Stabilizzatori Outriggers Calage Abstützungen Estabilizadores		Pneumatici Tyres Pneumatiques Bereifung Neumáticos		Rotazione Slewing Orientation Drehwerk Giro
	Contrappeso Counterweight Contrepoids Gegenwicht Contrapeso		Raggio Radius Portée Ausladung Radio		Marcia Gear Rapport Gang Marcha		Gamma lenta Low range Gamme basse Gelände Gama lenta		Gamma veloce High range Gamme haute Strasse Gama alta
	Argano principale Main hoist Treuil principal Haupthubwerk Cabrestante principal		Argano ausiliario Auxiliary hoist Treuil auxiliaire Hilfshubwerk Cabrestante auxiliar		Sfilo braccio Boom telescoping Télescopage de flèche Teleskopieren Telescopaje de pluma		Elevazione braccio Boom elevation Relevage de flèche Wippwerk Elevación de pluma		Bozzello Hookblock Crochet moufle Hachenflasche Gancio



» www.locatell Crane.com



LOCATELLI CRANE srl

Via Lombardia n. 32 - 24030 Mapello (BG) - Italy - Tel. +39 035 4945066 - Fax +39 035 4945549 - info@locatell Crane.com